



Origami RE

Scheda prodotto
Specifications
Fiche technique
Spezifikationen

Origami RE

design: R&D Leyform

Origami RE lega alla linea sottile e ormai collaudata di tutta la famiglia Origami un elemento in più. Lo schienale in rete infatti si fa apprezzare per la sua semplicità e traspirabilità, rendendola particolarmente adatta in ambienti lavorativi dove viene richiesta una presenza assidua e costante.

Origami RE combines the essential and ergonomic design of Origami collection with a breathable mesh seat and backrest making this chair extremely comfortable for intense use.

Ajoutez à la ligne contemporaine et légère de la collection Origami le tissu résille. Le voilà Origami RE, le siège de travail à vivre pendant toute la journée.

Origami RE verbindet mit der schlanken und nunmehr bewährten Linie der gesamten Origami-Familie ein weiteres Element. Die Rückenlehne aus Netz ist beliebt aufgrund ihrer Schlichtheit und Atmungsaktivität und macht den Stuhl besonders geeignet für Arbeitsumgebungen, in denen eine ständige und kontinuierliche Präsenz gefordert ist.



70211
h1165 . d680 . w680



70221
h965 . d680 . w680



702211
h965 . d680 . w680



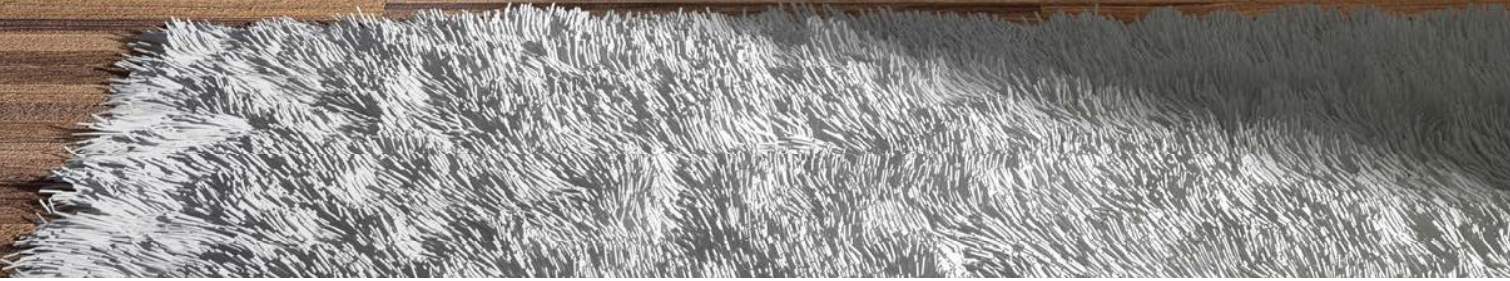



Sedute direzionali

Executive chairs

Sièges direction

Chefsessel

Informazioni tecniche

Technical specifications

Fiche technique

Technische Spezifikationen



Origami RE

design: R&D Leyform

Movimento oscillante. Struttura metallica in acciaio cromato. Braccioli in alluminio cromato. Base in alluminio lucido. Ruote in nylon con freno (tipo H). Unico pezzo in rete termosaldata per sedile e schienale, disponibile in 4 colori: nero, grigio chiaro, antracite e bianco. Questo modello è disponibile nelle versioni presidenziale, direzionale, visitatore con pistone autoallineante e visitatore con base a slitta in acciaio.

Tilt mechanisms in different options with individual tension control. Chromed metal side frames. Seat and backrest heat welded mesh cover. Chromed aluminium armrests. Elegant backrest support bar of chromed metal. Polished aluminium base with nylon self-braking castors. Visitor chairs with chromed cantilever frame or swivel with automatic return.

Mécanismes basculants en diverses versions avec réglages individuels tension. Chassis metal tubulaire chromé. Assise et dossier en maille filet thermo-soudée. Accoudoirs en aluminium chromé. Barre de renfort chromé à l'extérieur du dossier. Piètement en aluminium poli et roulettes en nylon autofreinantes. Fauteuils visiteur avec chassis luge chromé ou giratoire avec retour automatique.

Verschiedene Wippmechanik-Optionen mit Gewichtseinstellung. Polsterung aus Pu-Schaum. Gestell aus verchromtem Stahlrohr. Sitz- und Rückenlehne aus thermogeschweisstem Netz. Armlehnen Alu verchromt. Fusskreuz aus poliertem Alu-Druckguss und lastabhängig bremsenden Rollen, aus Nylon. Besuchersessel mit verchromtem Freischwingergestell bzw. drehbar mit Rückholfeder.



13

RE

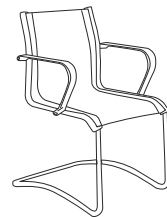

1165



680



680



965



680



680



850



625



580

Leyform Srl

Via Pertini, 1
31014 Colle Umberto
Treviso - Italy



Tel. +39 0438 430 050

Fax +39 0438 430 487

www.leyform.com
info@leyform.com



Origami panca

Scheda prodotto
Specifications
Fiche technique
Spezifikationen

Origami panca

design: R&D Leyform

Origami panca è disponibile in diverse lunghezze, fino a raggiungere quattro posti totali. Può essere personalizzata con due tipi di gambe e due differenti braccioli. Il tavolino portariviste infine consente di separare la struttura inserendo un elemento utile a dividere in più parti la composizione.

Origami panca, a modular bench system available in configurations from one to four seater. Choose the legs and the armrests you prefer, also available with a coffee table.

Origami, une banquette sur poutre idéal pour une installation individuelle ou pour des configurations multiples jusqu'à quatre sièges et la possibilité de les personnaliser avec des petites tables et différents accoudoirs et piètements.

Die Origami Traversenbank ist in verschiedenen Längen mit bis zu vier Sitzplätzen erhältlich. Sie kann personalisiert werden mit zwei verschiedenen Beinen und zwei unterschiedlichen Armlehnen. Der Zeitungstisch erlaubt eine Trennung der Struktur, indem ein Element eingefügt wird, das die Komposition in mehrere Teile unterbricht.



72000

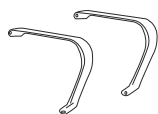

72100



72105



6664

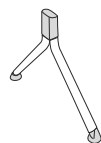

6964

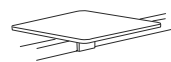

6620





Collettività

Public seating
Sièges collectivité
Mehrzweckstühle

Informazioni tecniche

Technical specifications
Fiche technique
Technische Spezifikationen



Origami TD panca

design: R&D Leyform

Modello disponibile nella versione con sedute fisse montate su barra in acciaio verniciato nero in varie composizioni fino a 4 posti.
Struttura metallica in acciaio cromato. Braccioli in alluminio cromato. Imbottitura del sedile e dello schienale in materiale accoppiato. Gambe in acciaio cromato.

Beam mounted fixed seats, available in 2-3-4-seater modules. Frame of chromed steel. Upholstered seat and backrest. Black painted beam. Free-standing metal legs, chrome plated.

Sièges fixes sur poutre, disponibles en modules de 2-3-4 sièges. Chassis sièges en tube d'acier chromé. Assise et dossier revetus. Poutre en métal noir. Pied mobile en acier chromé.

2-3-4-Sitzer Traversenbänke. Gestell aus verchromtem Stahlrohr. Sitz- und Rückenlehne gepolstert. Traverse aus Metall, schwarz. Freistehender Füße aus verchromtem Stahl.



BDEF
M2 P1 P

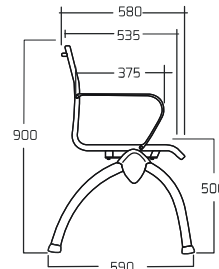
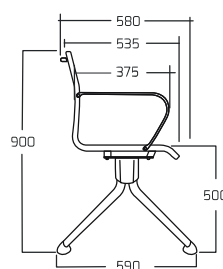
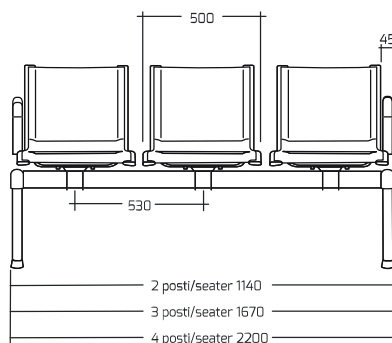

Leyform Srl

Via Pertini, 1
31014 Colle Umberto
Treviso - Italy



Tel. +39 0438 430 050
Fax +39 0438 430 487

www.leyform.com
info@leyform.com